

LINE

Tool: LINE

LINE: 2 Points



- specify the First point (left-click).
- specify the Second point (move cursor and left-click).
- right-click to 'back' (Escape once) or right-click Two times to 'exit'.
 - type 'C' and enter to close the path (must be 3 lines/entities at least).

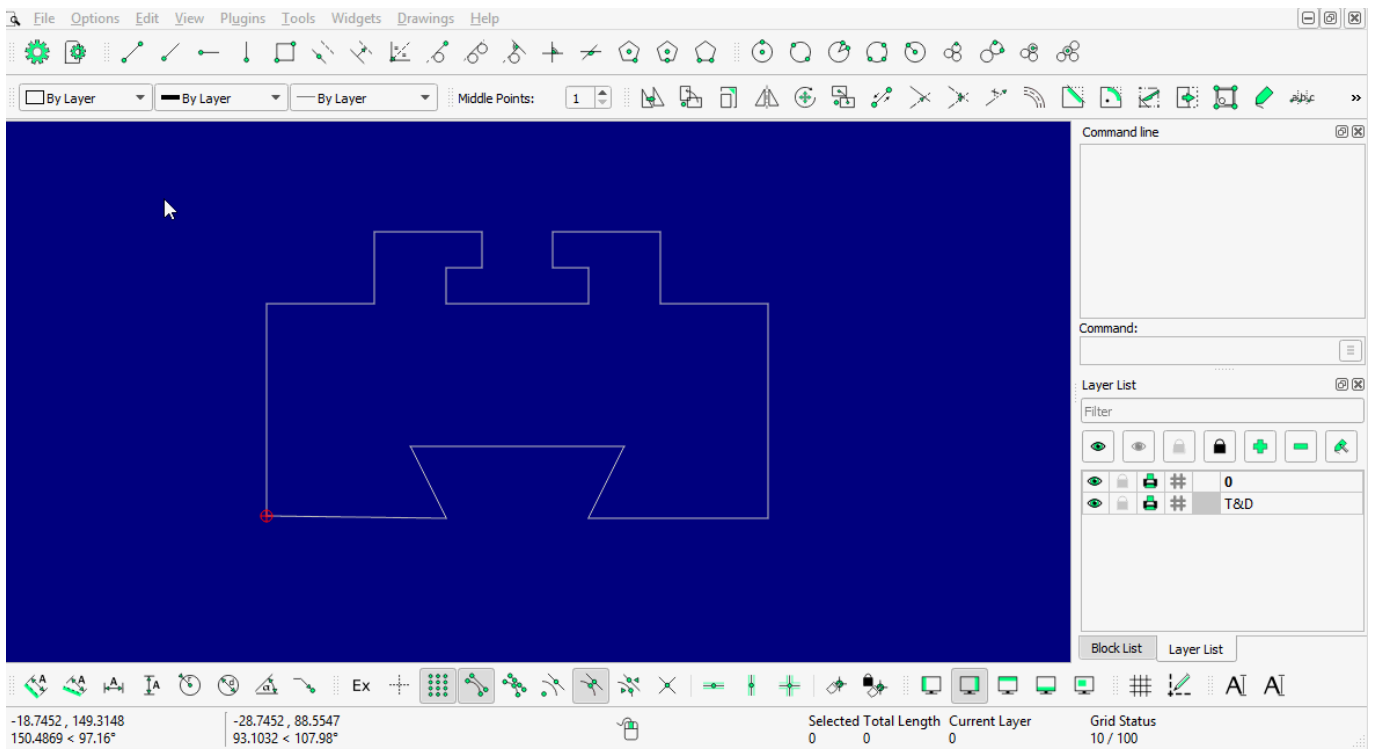

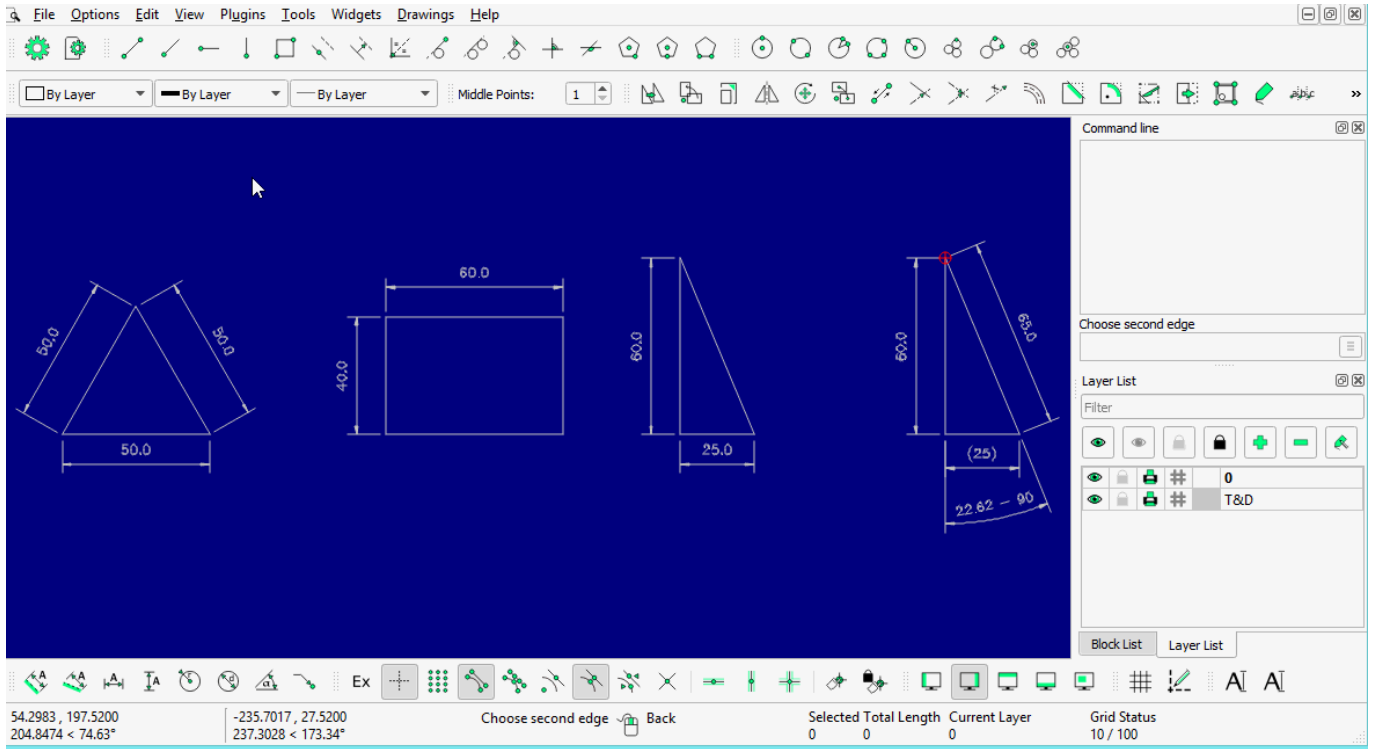

2 points with more detail (tips for drawing a specific length of a line; type the **BOLD** one into command-line).

- specify the First point (left-click).
- **@50<0** for straight line.
- **@50,50** for Square or **@50,30** for Rectangle.
- **@60<120** or **@60 < -120** for **60mm line at 120 degree**. (try {-}(minus) symbol before 'degree' and see what happen!!)

LINE: Angle



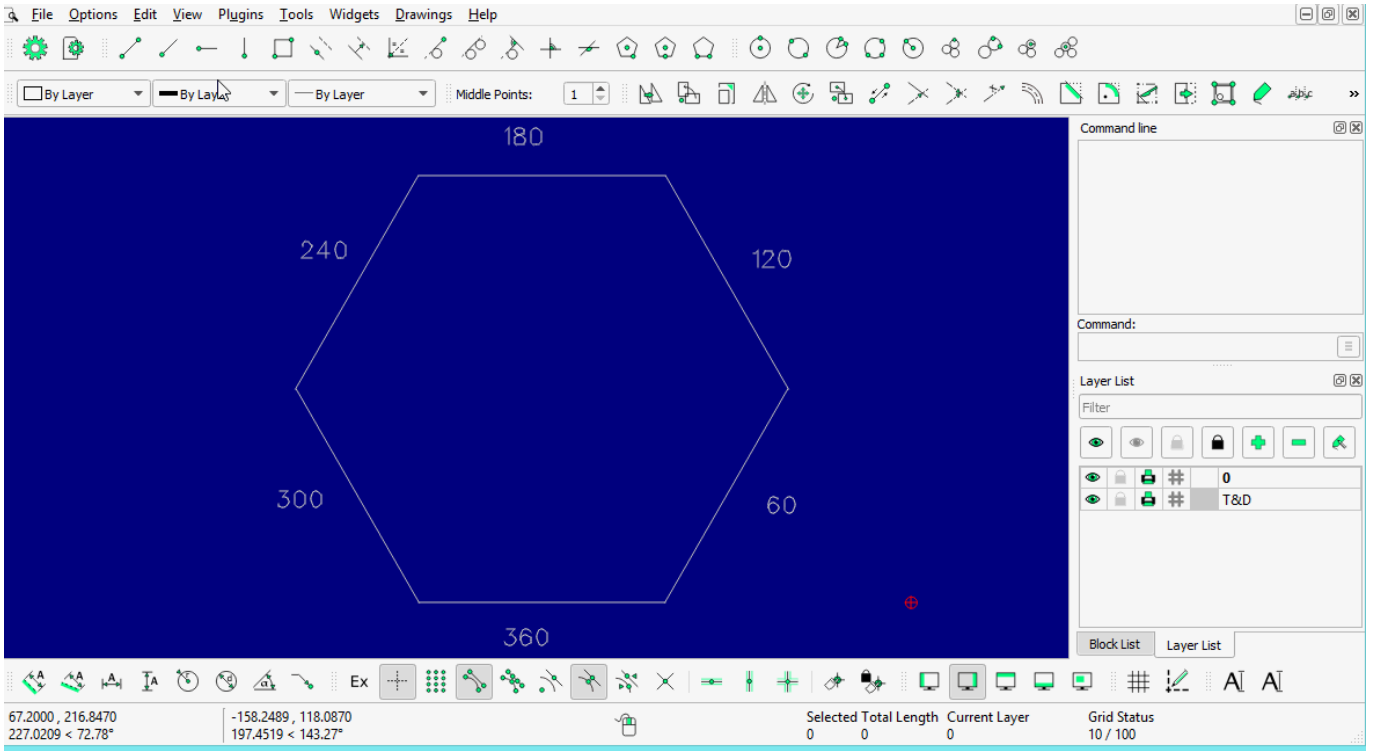

LINE: Horizontal

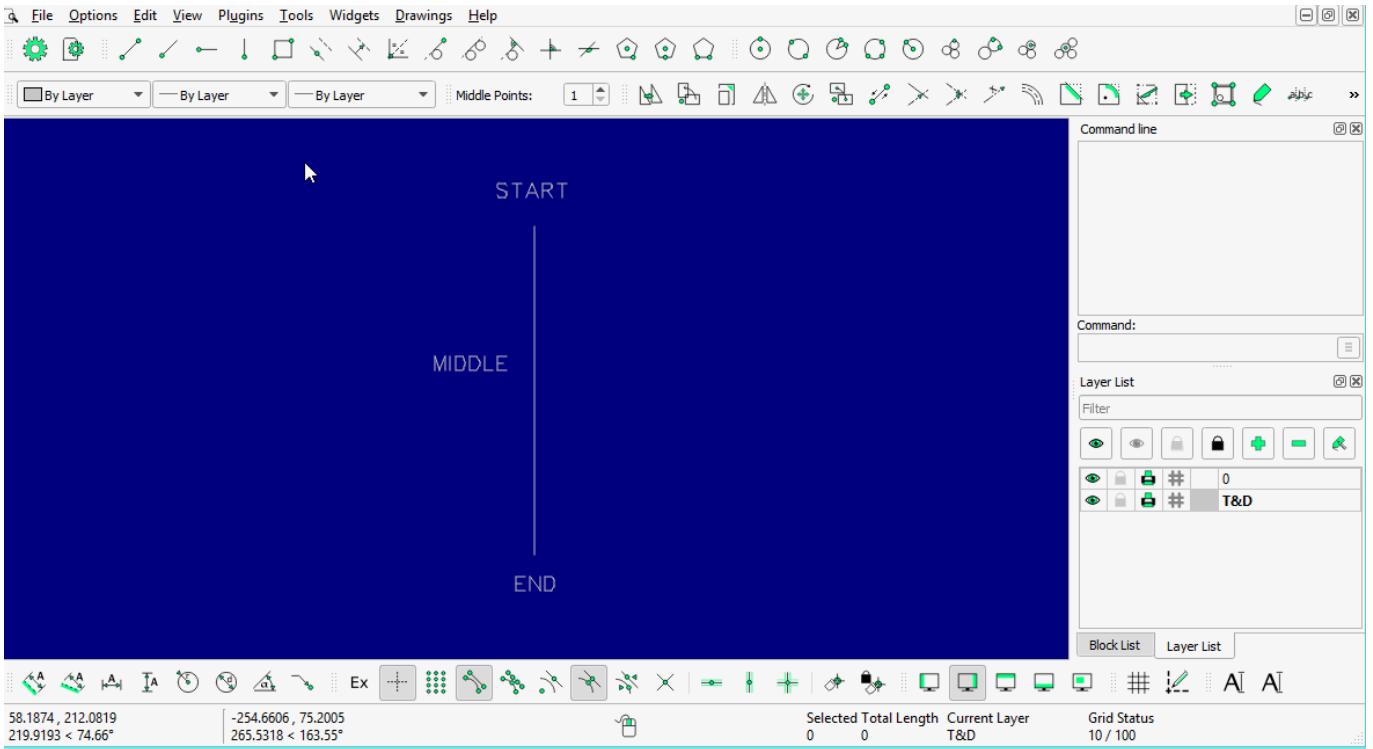

LINE: Vertical

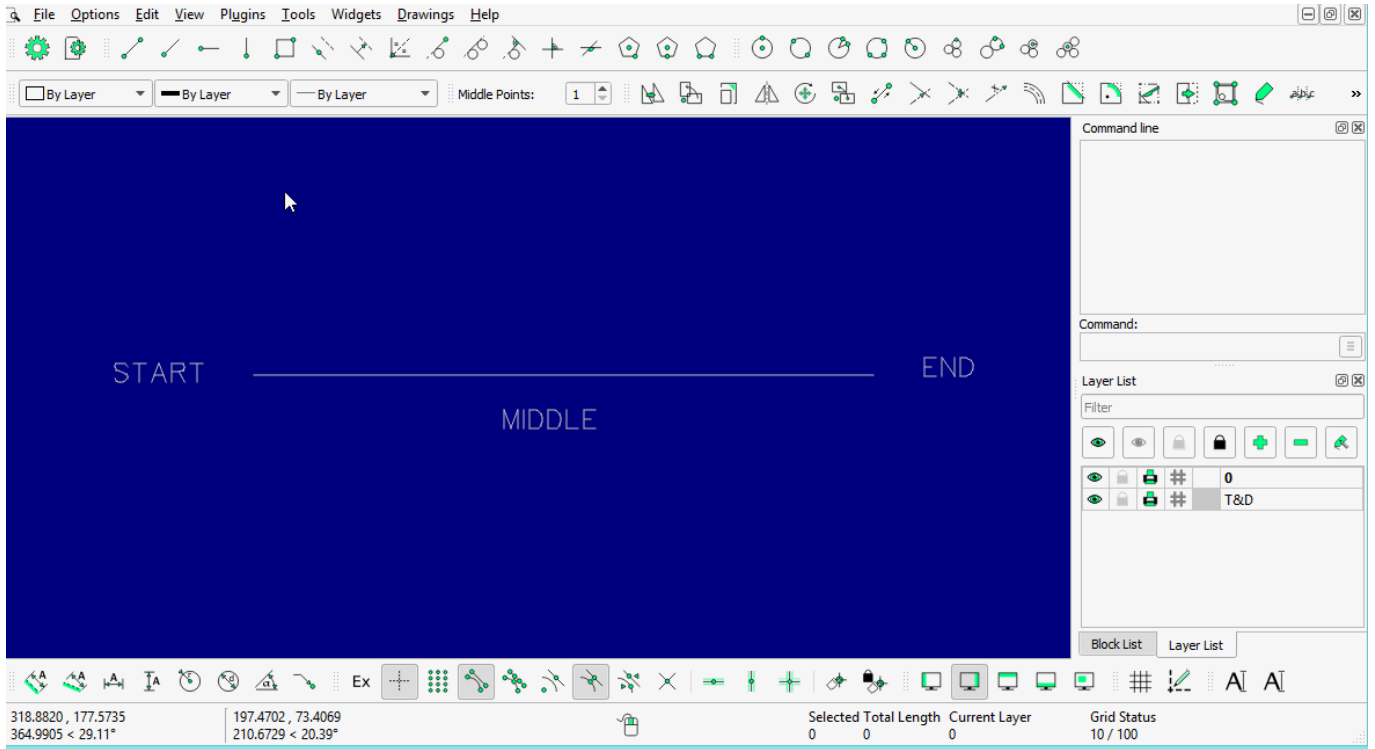

LINE: Rectangle

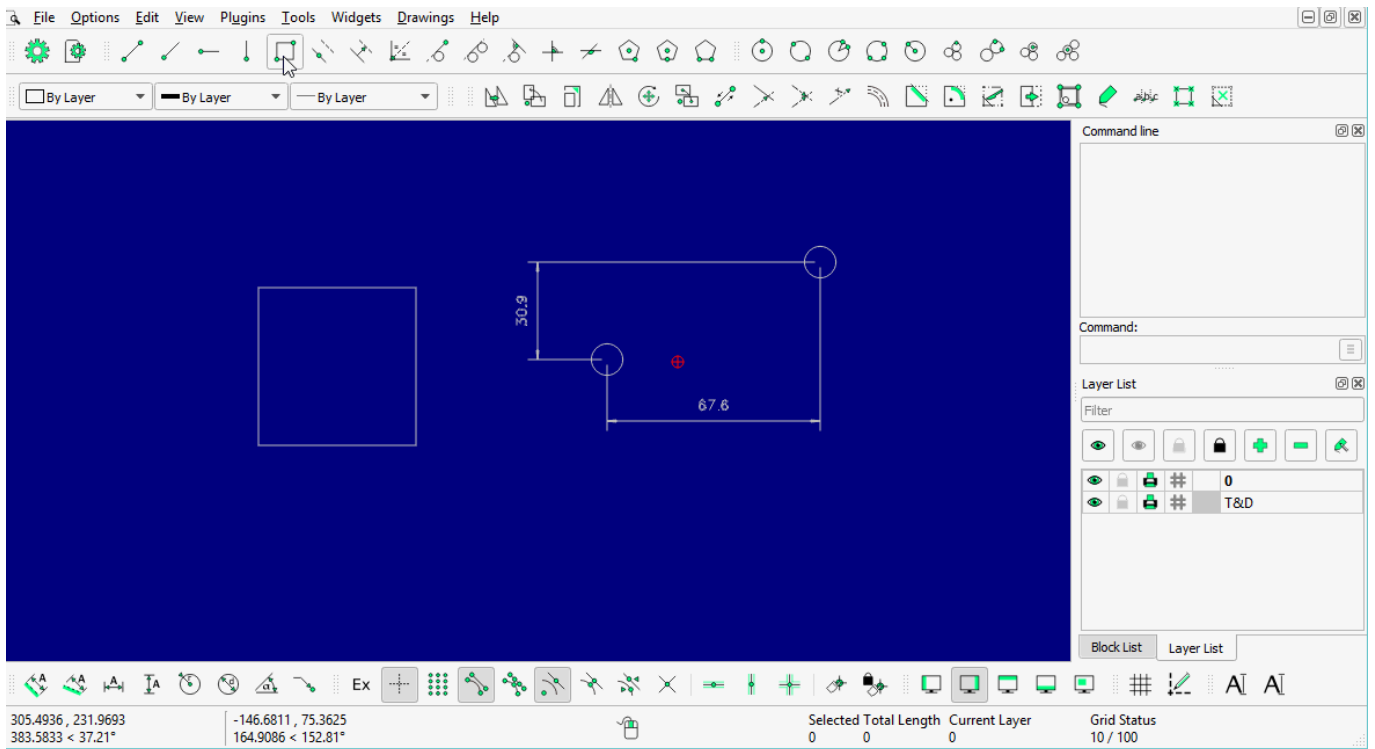

LINE: Parallel through point

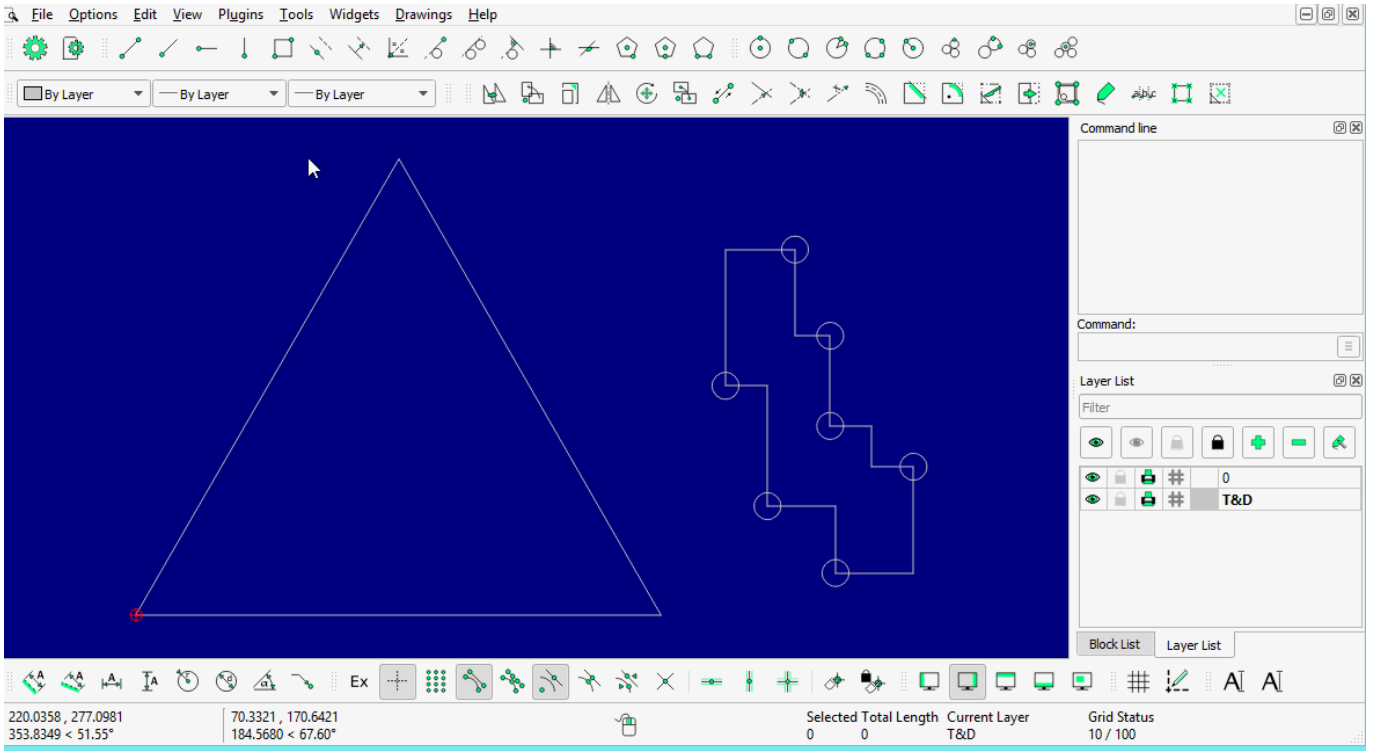

LINE: Parallel

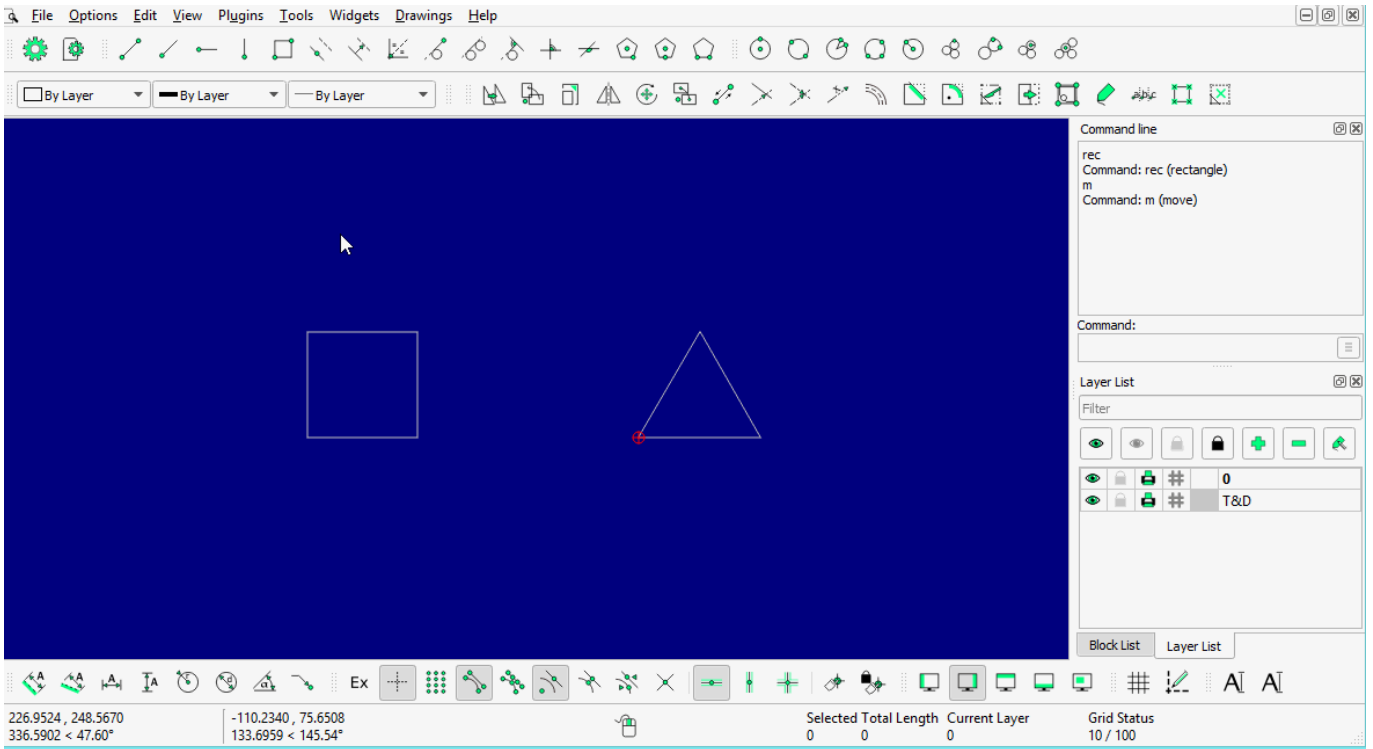

LINE: Bisector

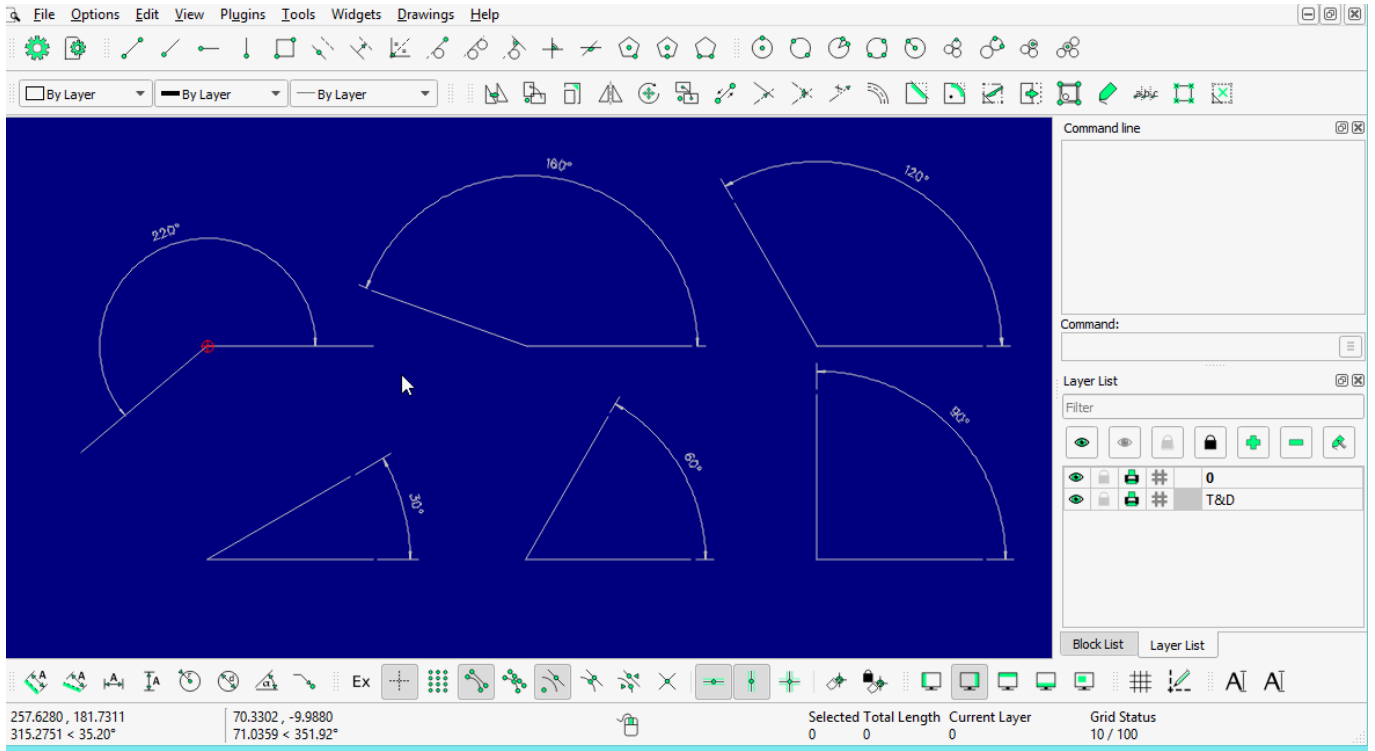

LINE: Tangent (P,C)

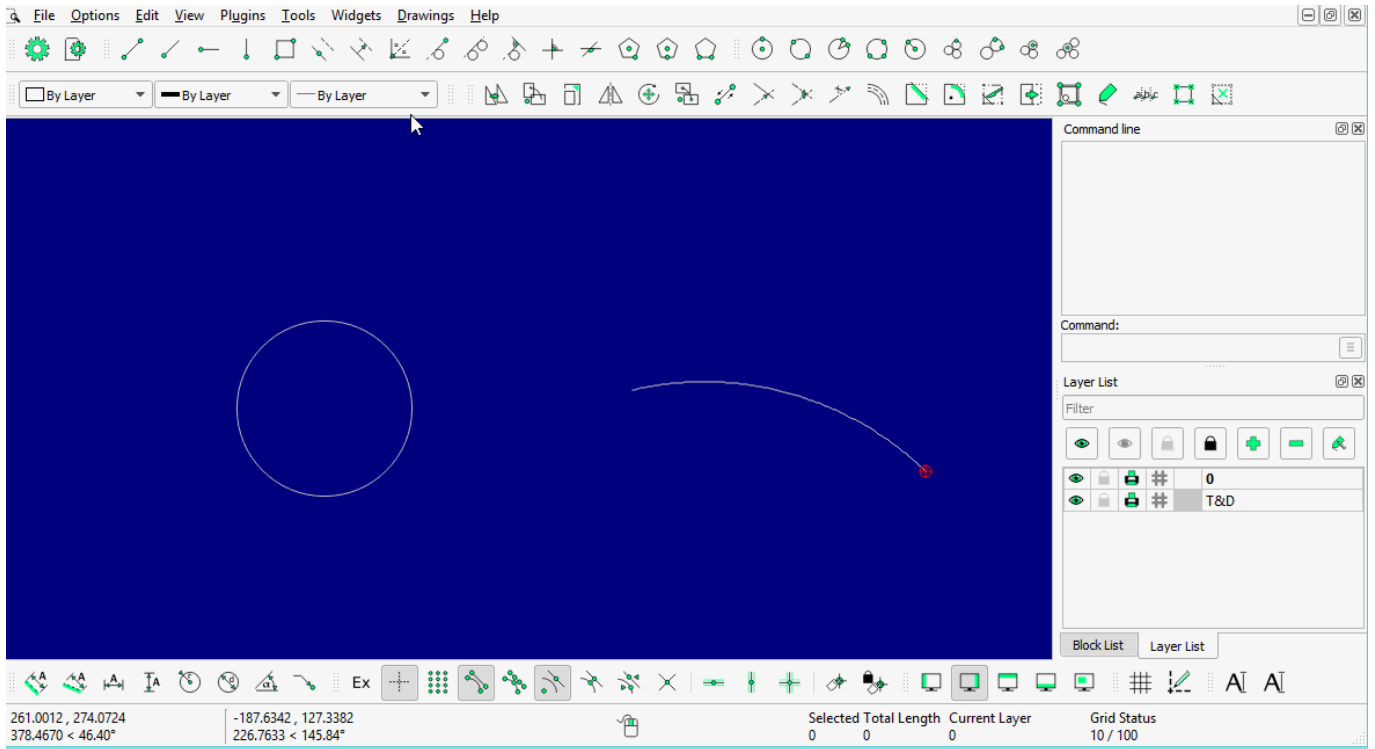

LINE: Tangent (C,C)

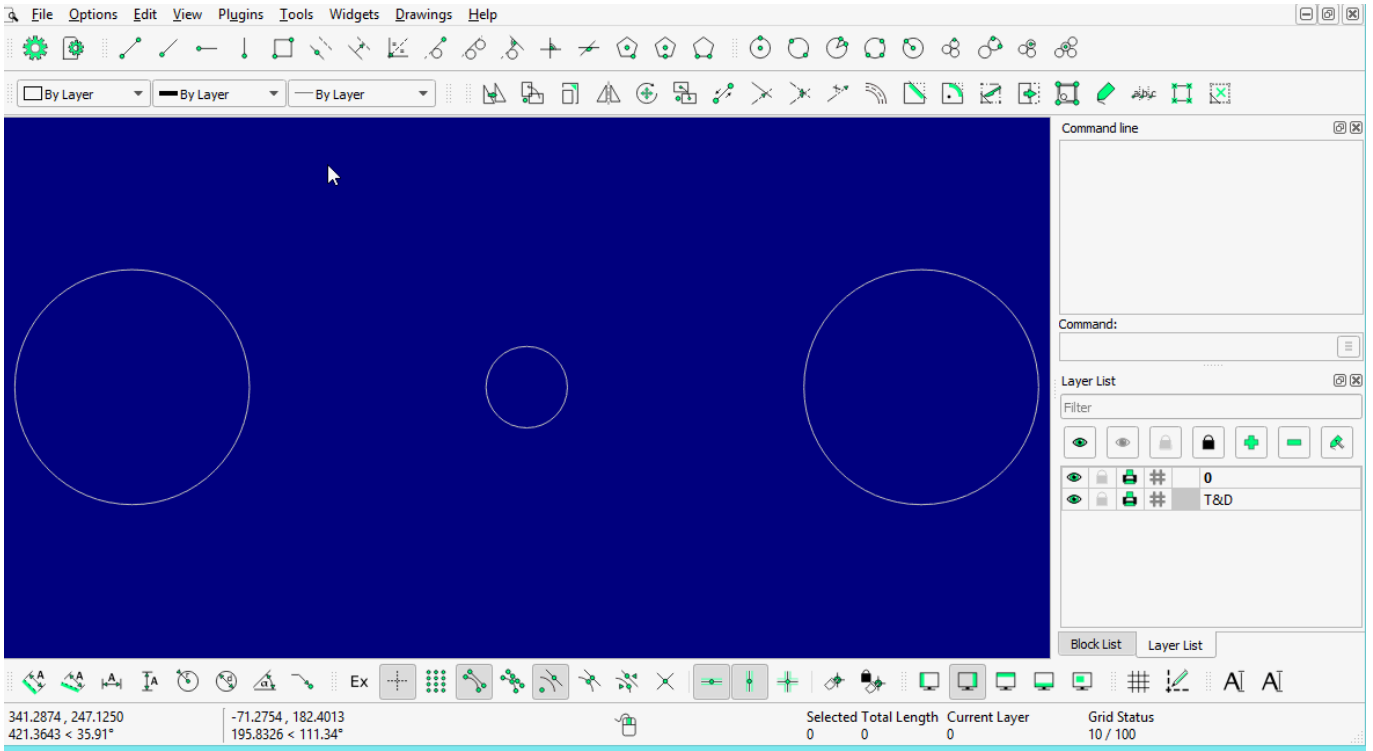

LINE: Tangent Orthogonal

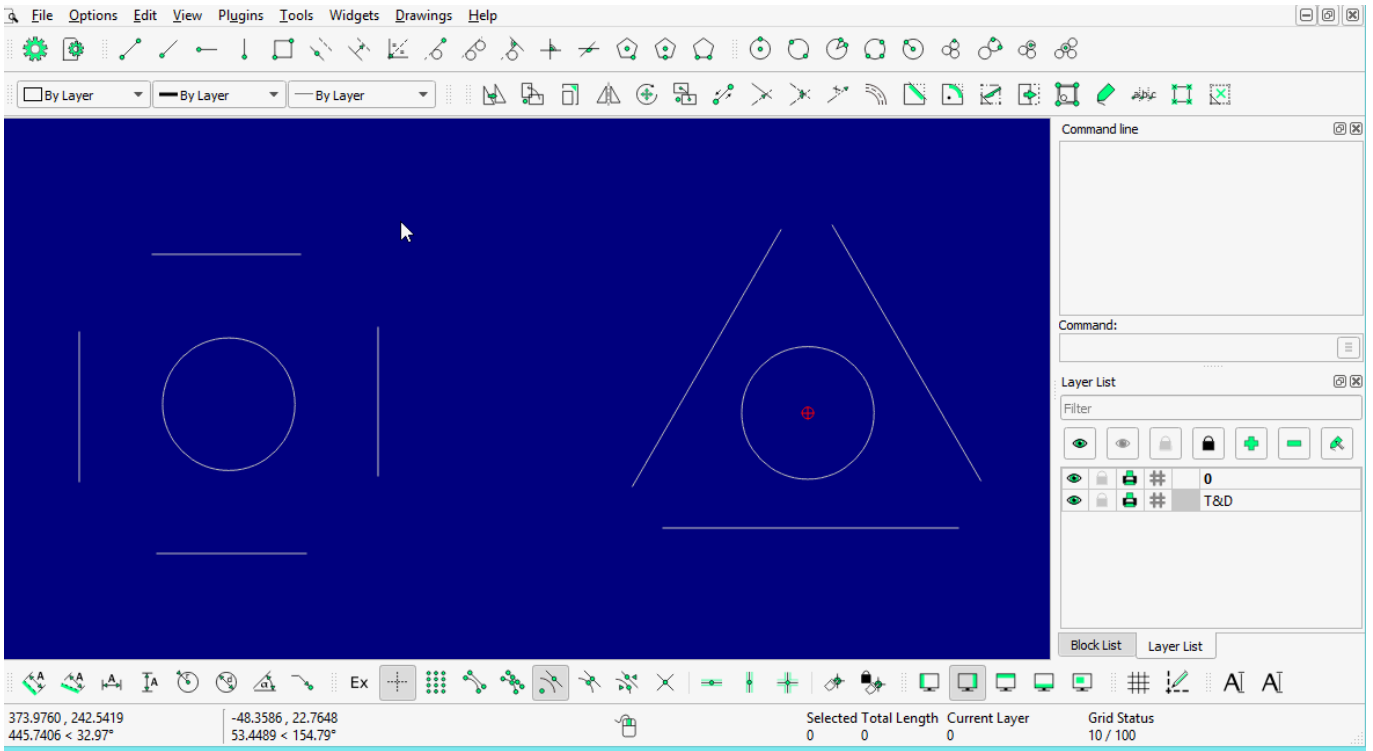

LINE: Orthogonal

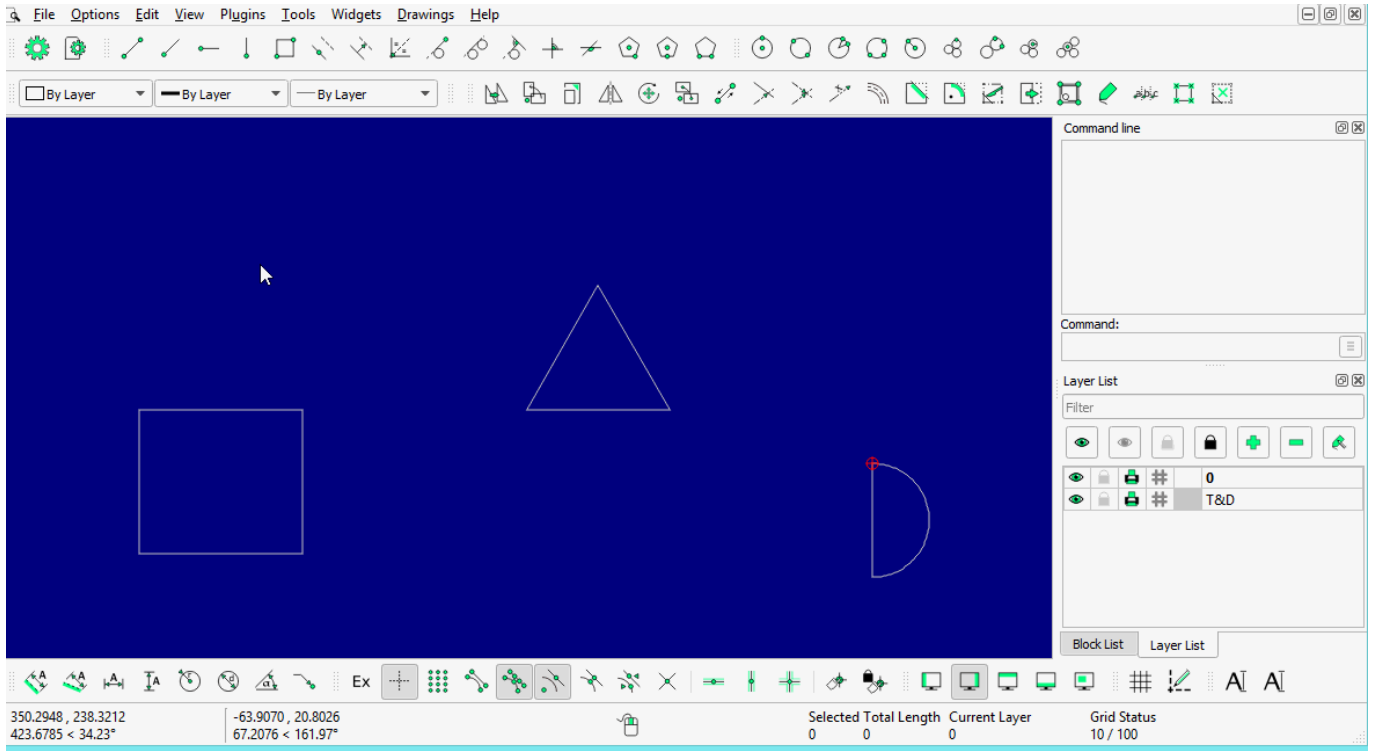

LINE: Relative Angle

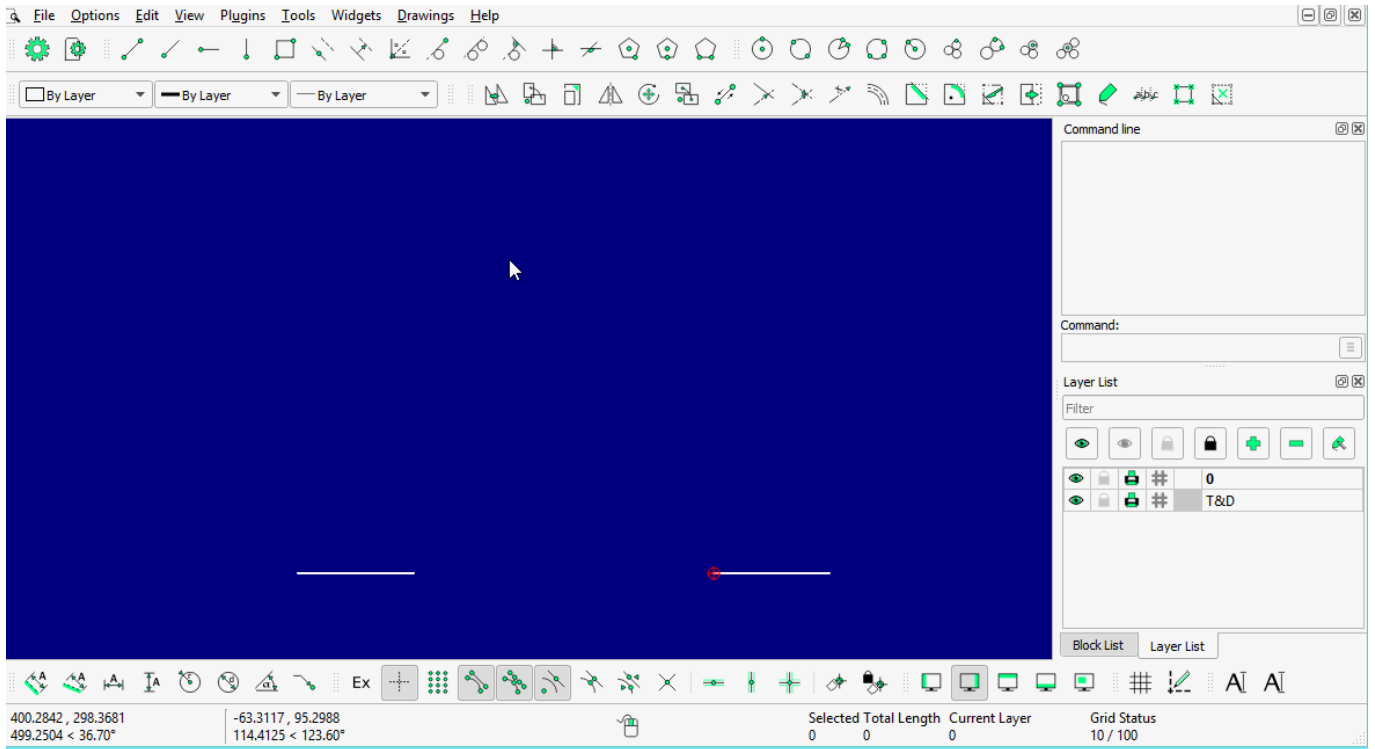

LINE: Polygon [(Cen,Cor), (Cen,Tan), (Cor,Cor)]

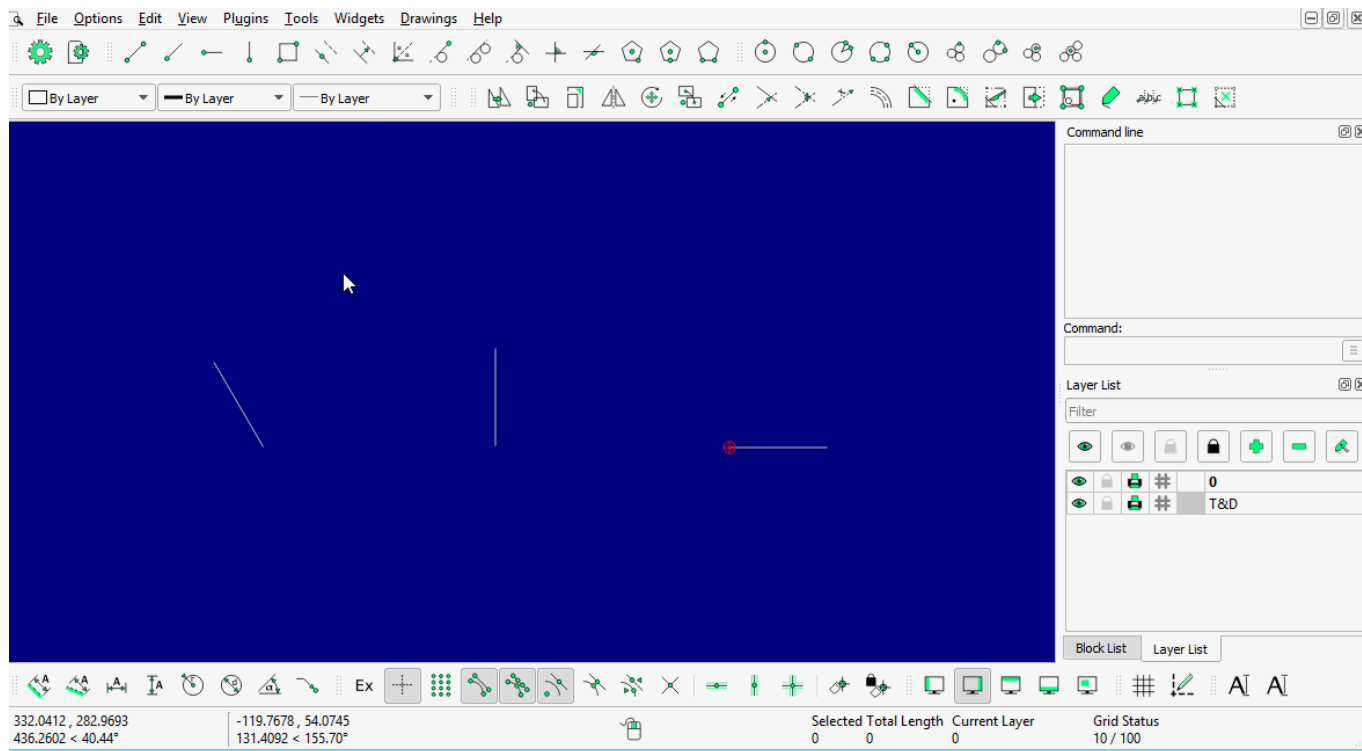

From:
<https://dokuwiki.librecad.org/> - Wiki

Permanent link:
<https://dokuwiki.librecad.org/doku.php/usage:line?rev=1592452654>

Last update: **2020/06/18 03:57**

