

LINE

Tool: LINE

LINE: 2 Points



- click the  icon.
- specify first point (left-click).
- specify second point
- Right-click to 'back' or press 'Esc' to exit.

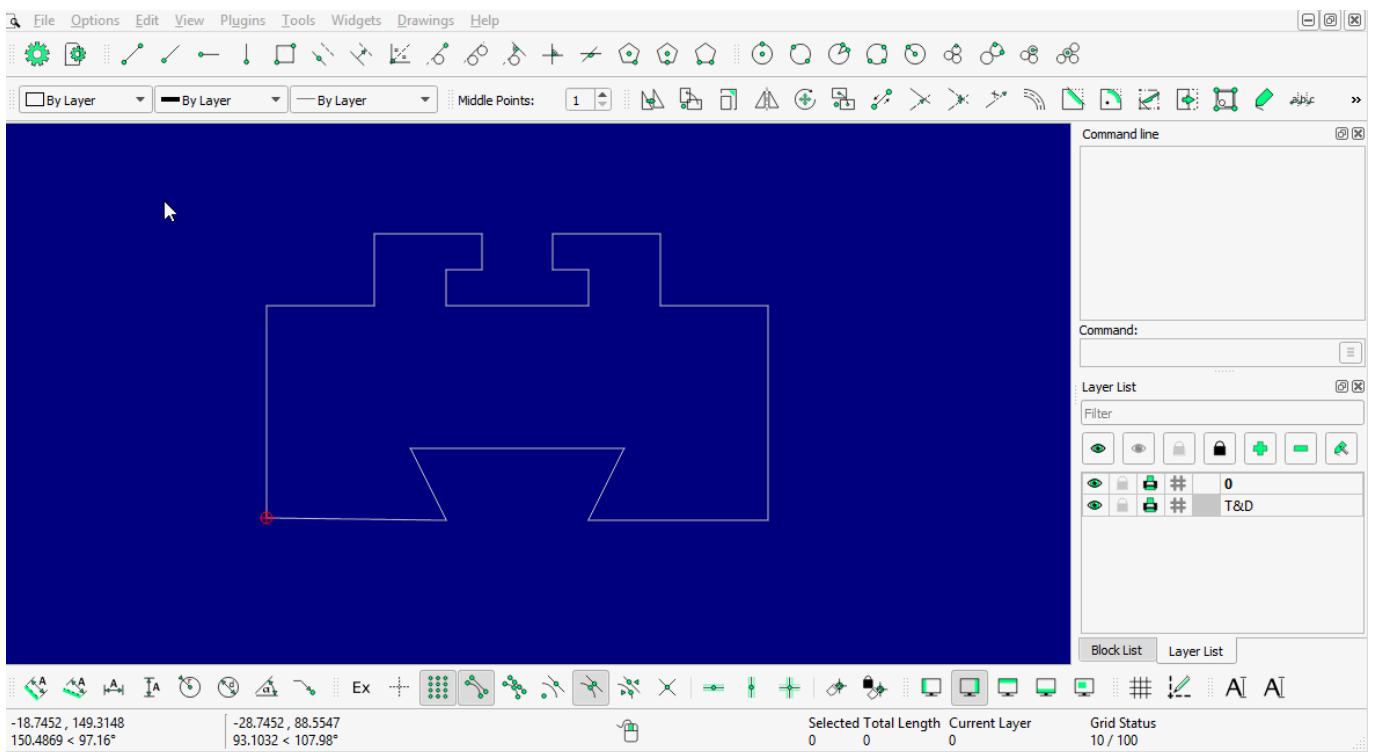

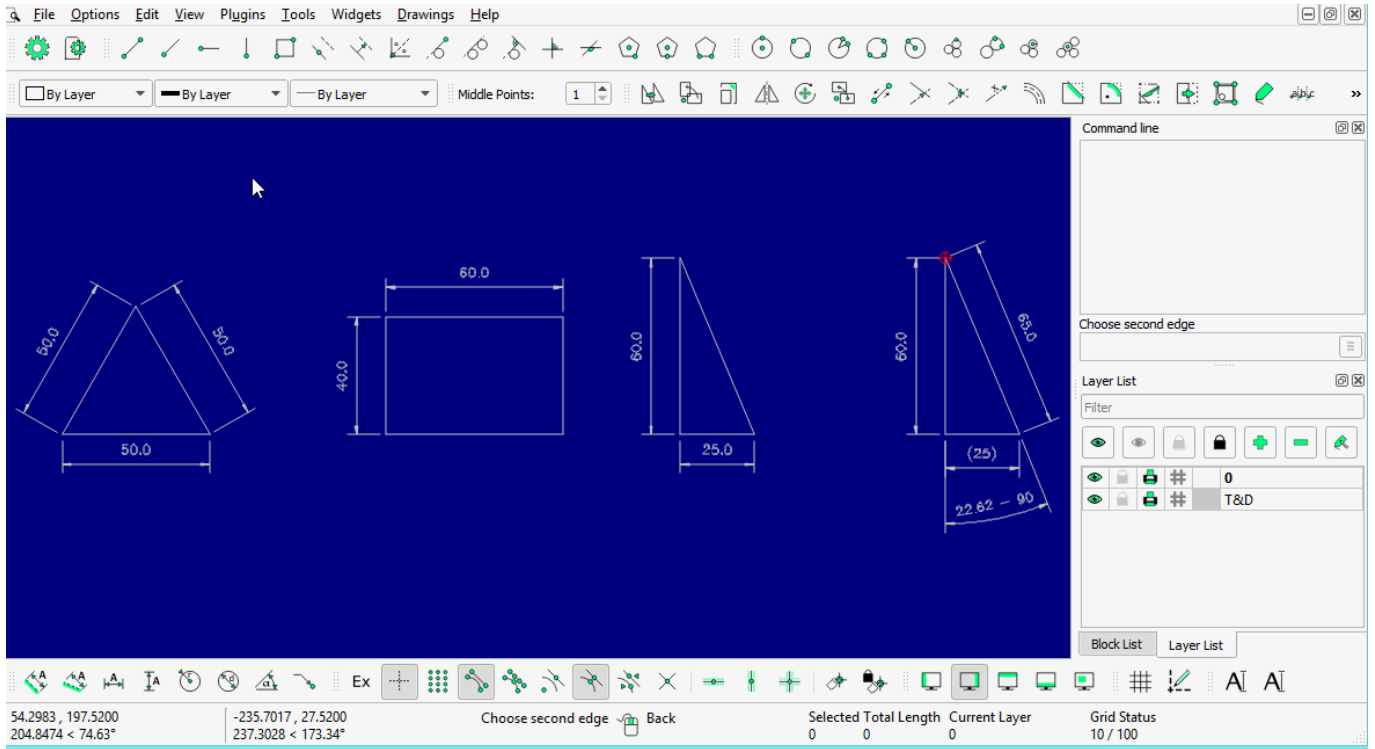

2 points with more detail (tips for drawing a specific length of a line; type the **BOLD** one into command-line).

- specify the First point (left-click).
- **@50<0** for straight line.
- **@50,50** for Square or **@50,30** for Rectangle.
- **@60<120** for 60mm line at 120 degrees. (try {-} (minus) symbol before 'degree' and see what happen!!)

LINE: Angle



- click the icon
- enter **angle** (see 'tool option').
- enter **length**.
- specify **start, middle, or end** snap point.

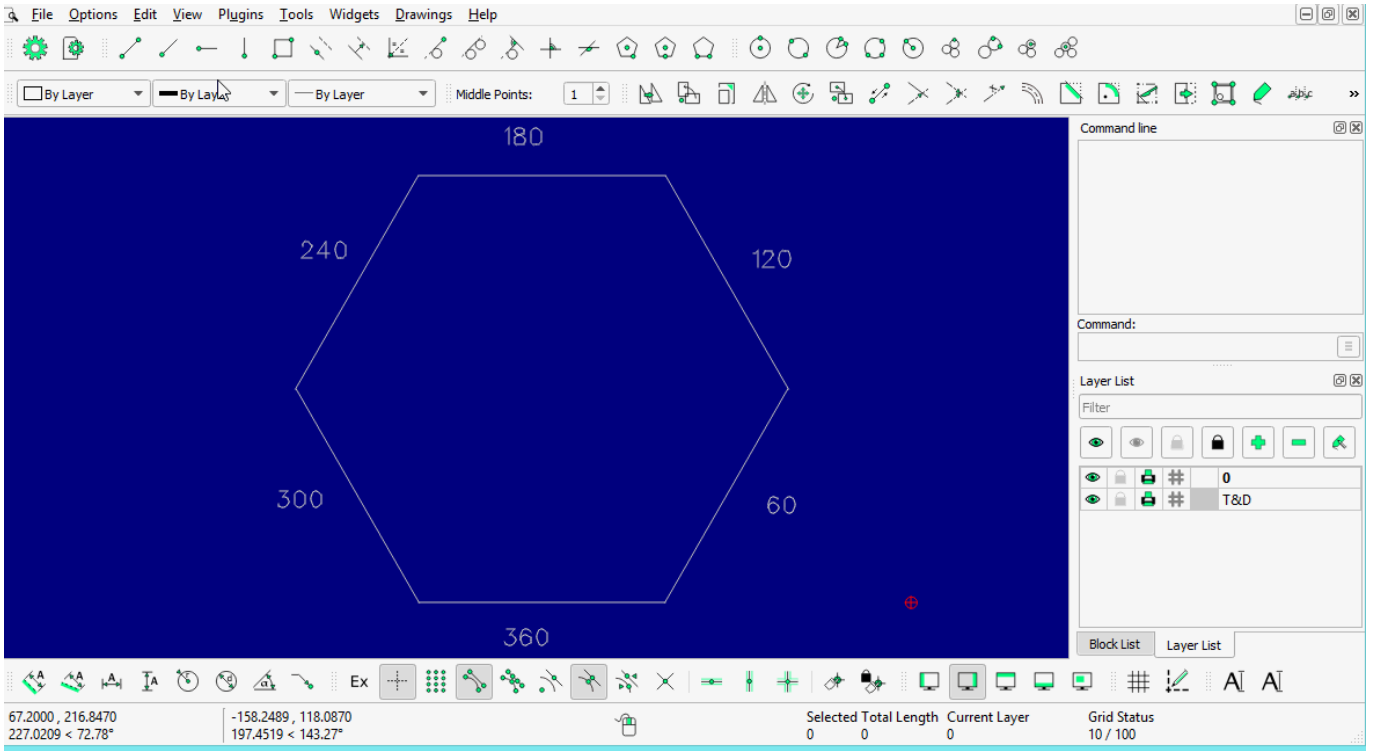

LINE: Horizontal

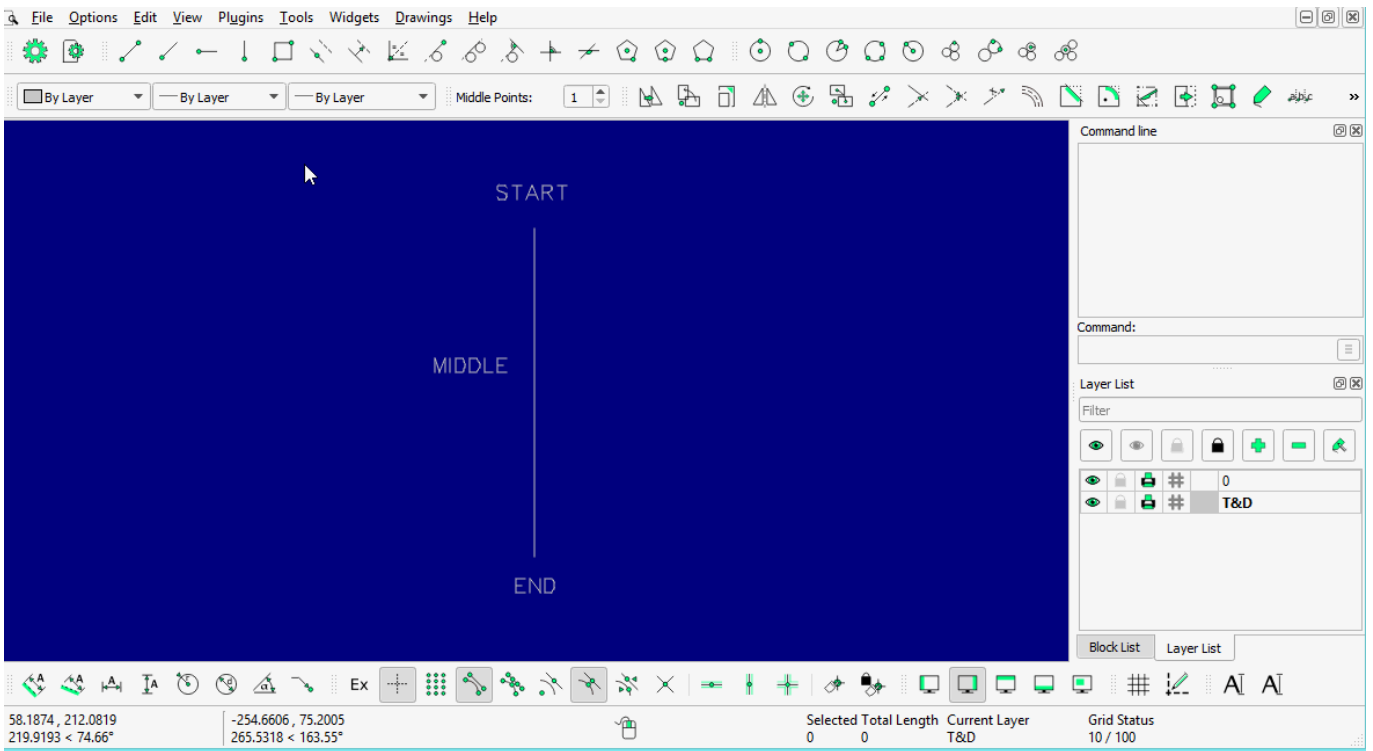

LINE: Vertical

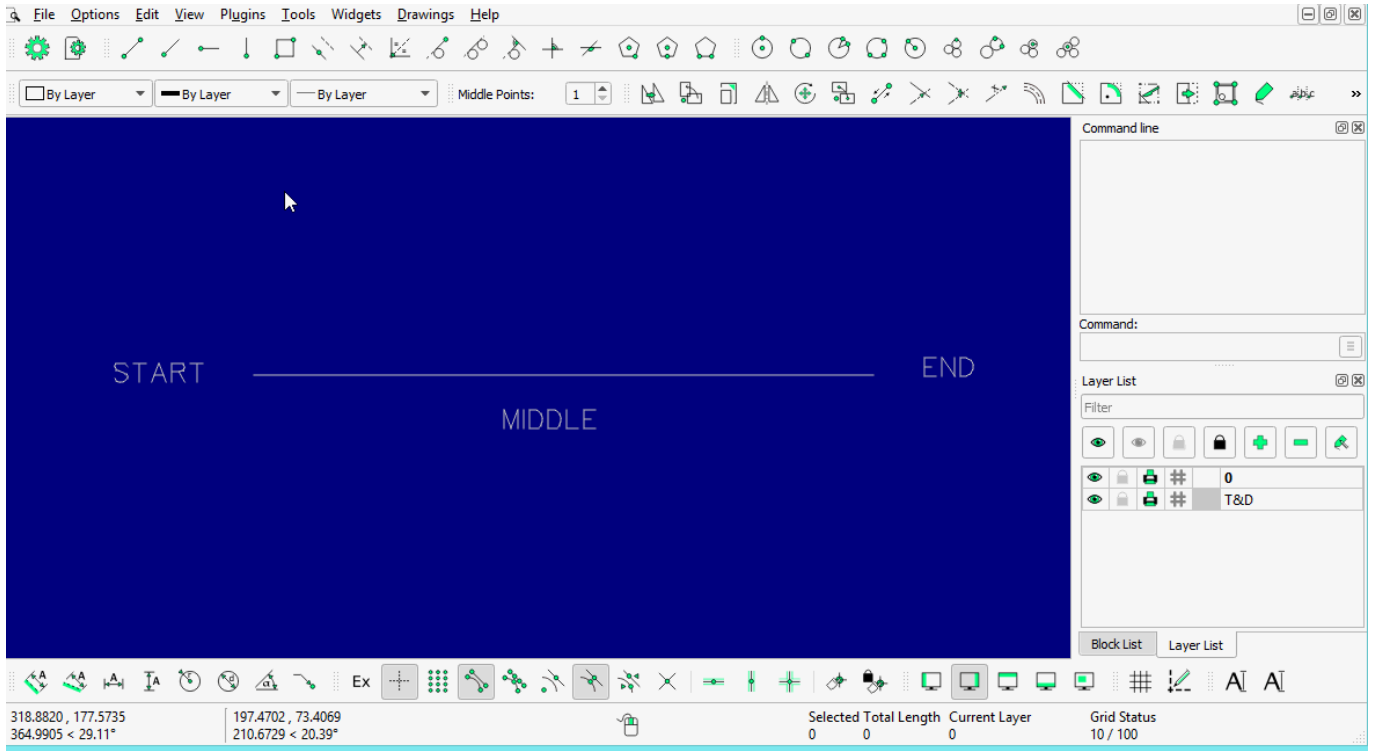

LINE: Rectangle

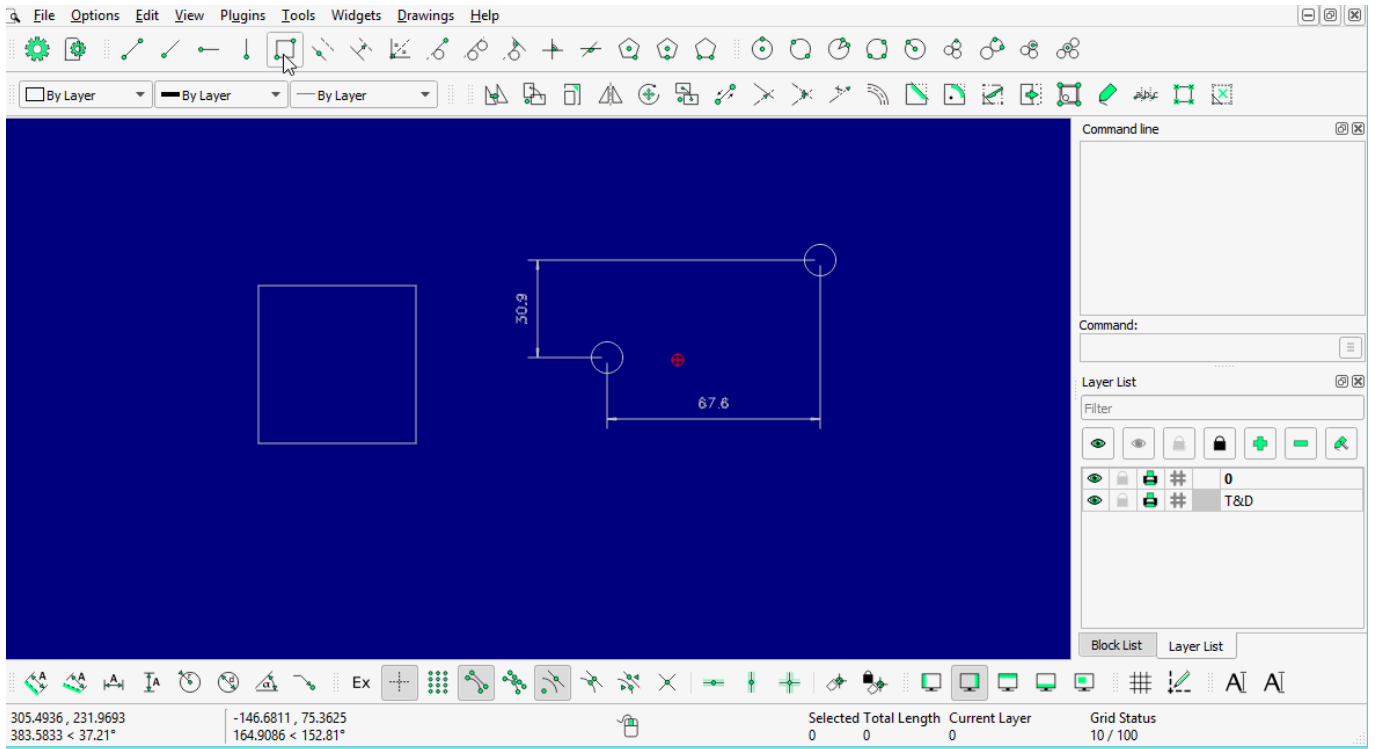

LINE: Parallel through point

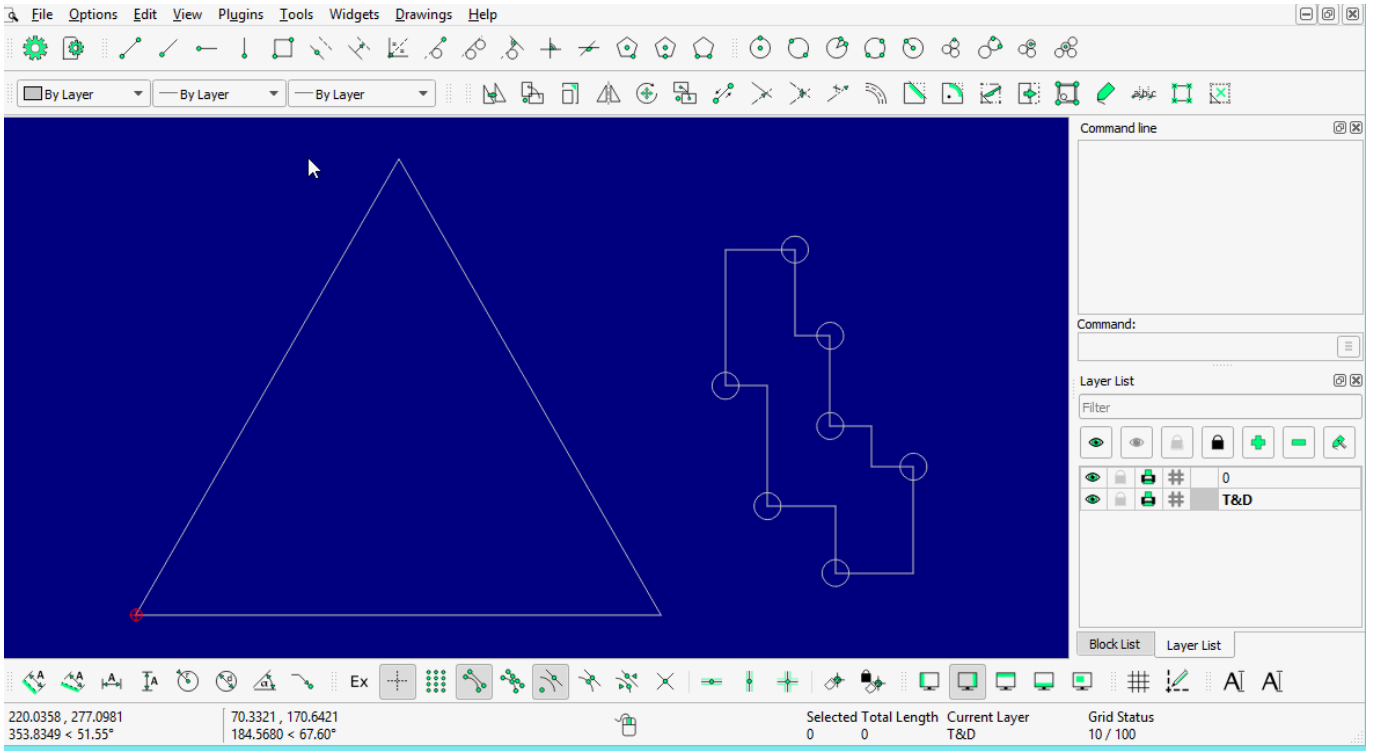

LINE: Parallel

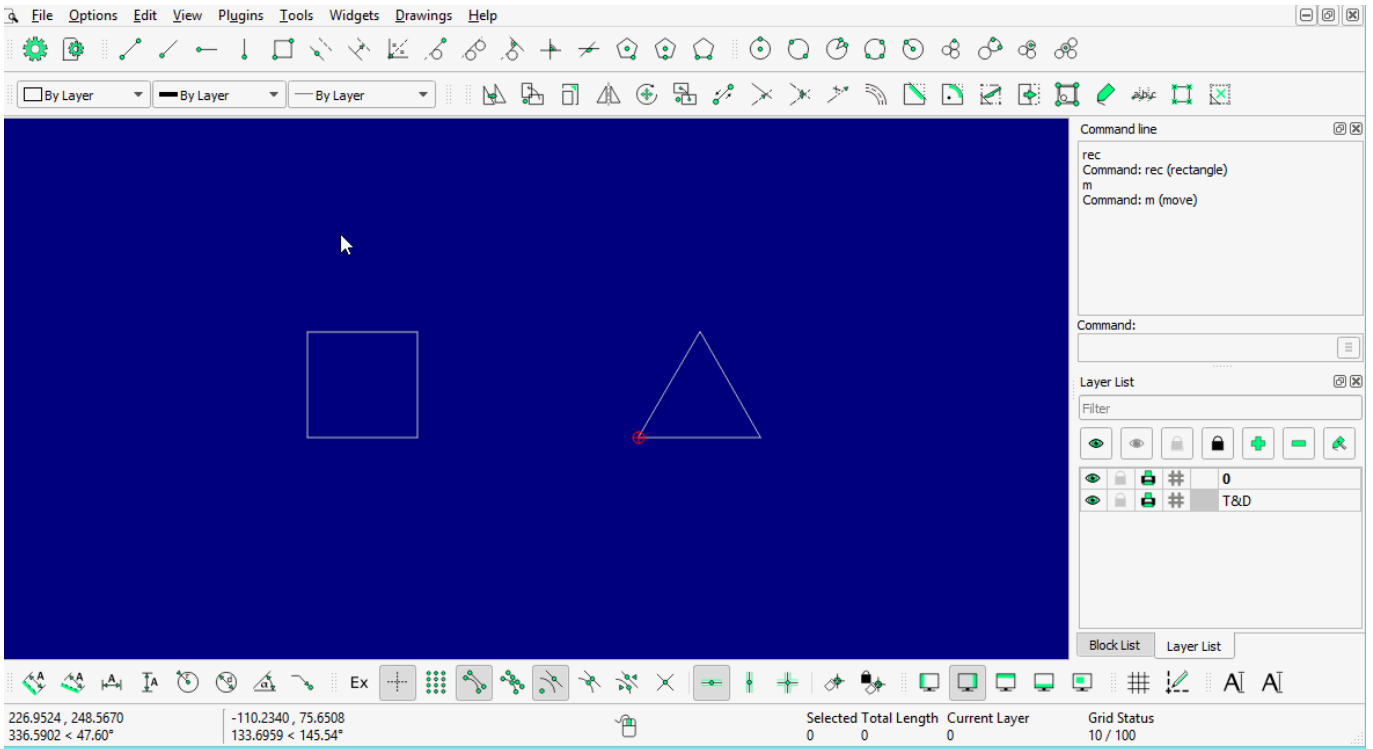

LINE: Bisector

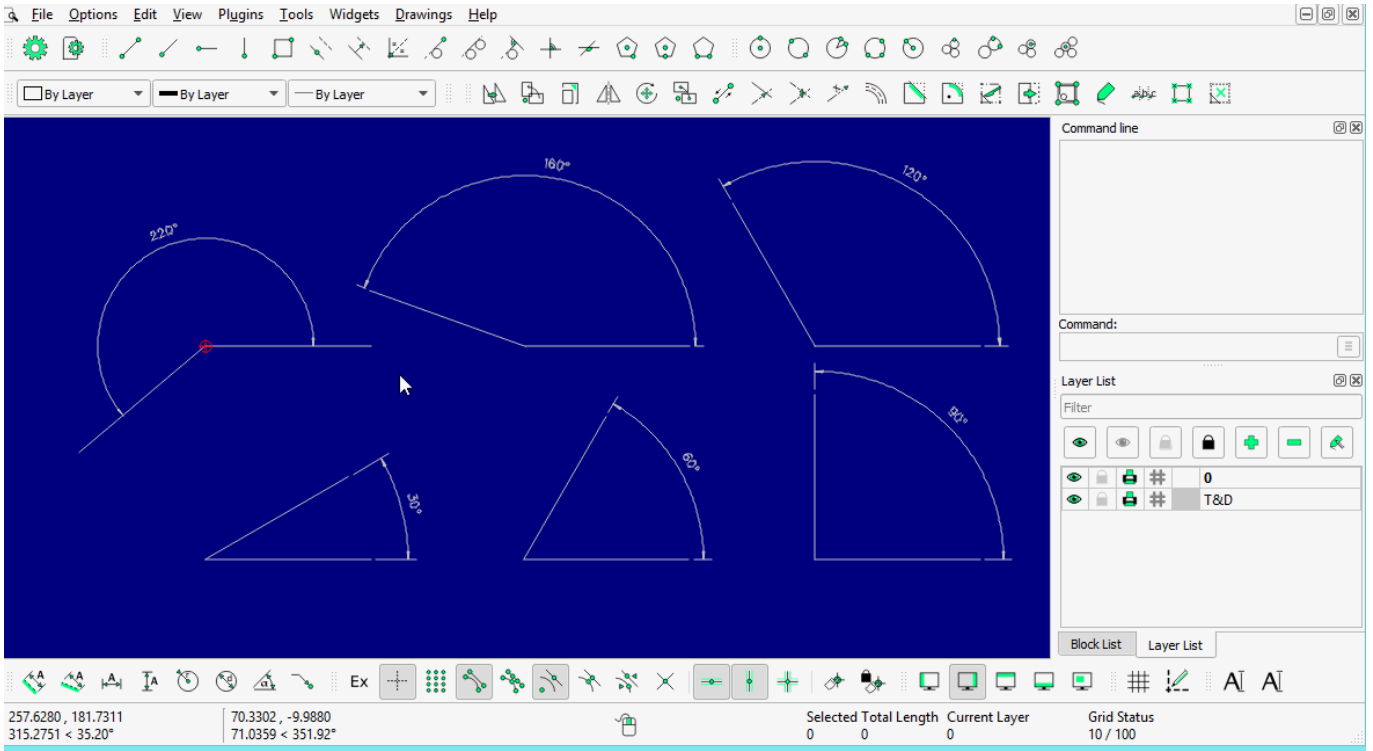

LINE: Tangent (P,C)

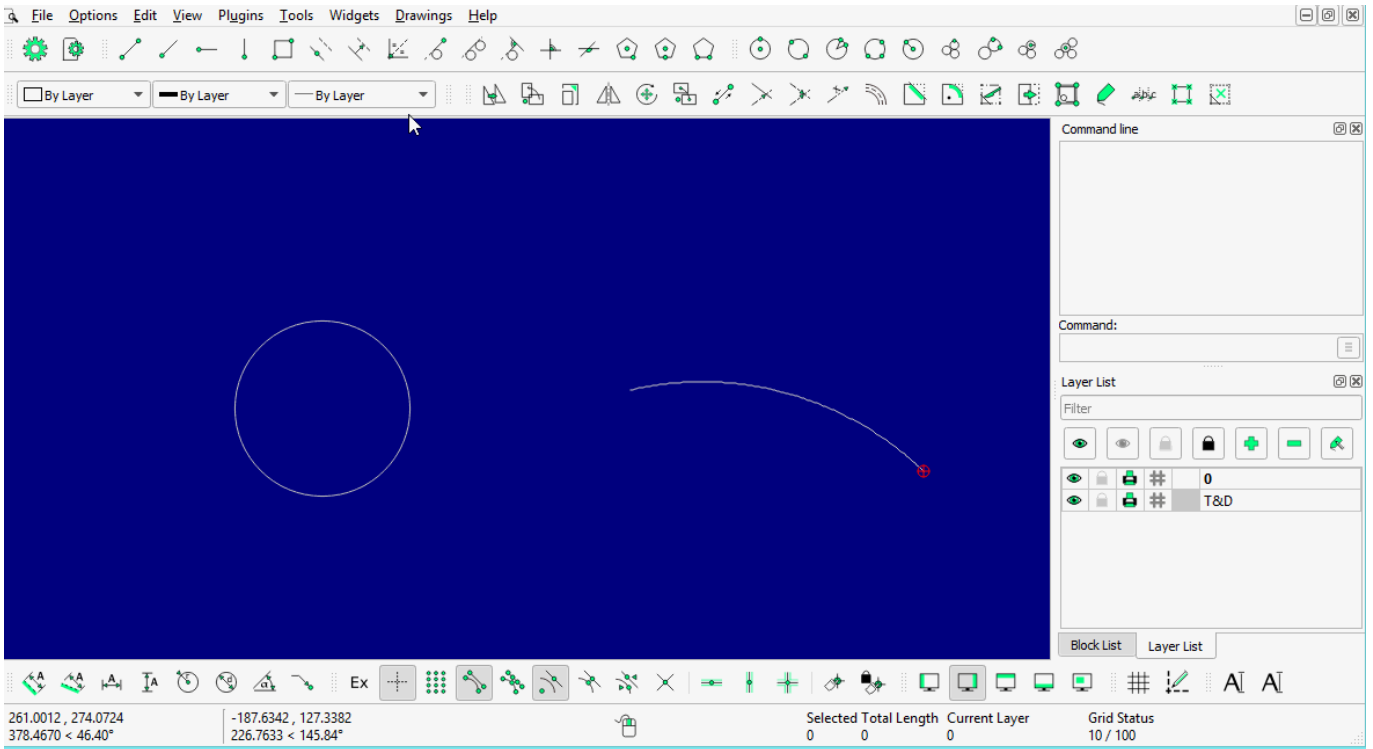

LINE: Tangent (C,C)

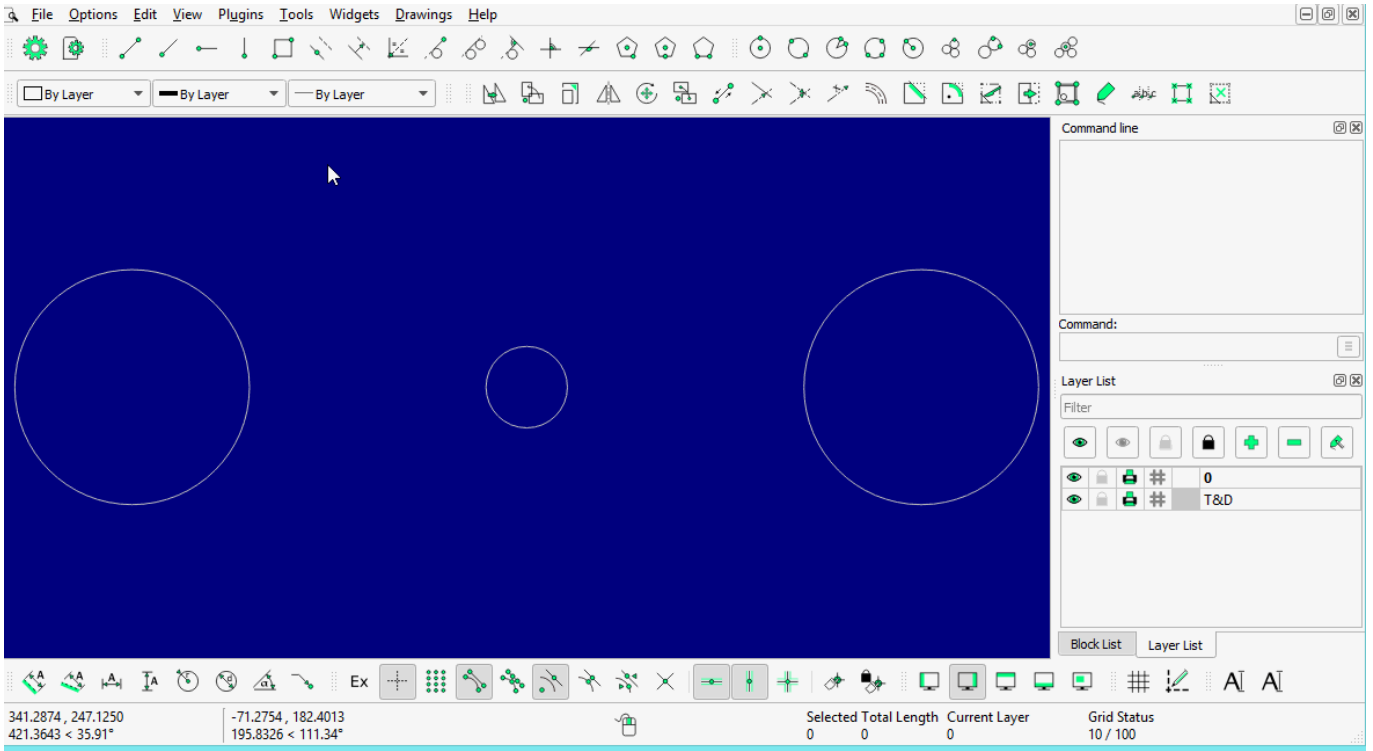

LINE: Tangent Orthogonal

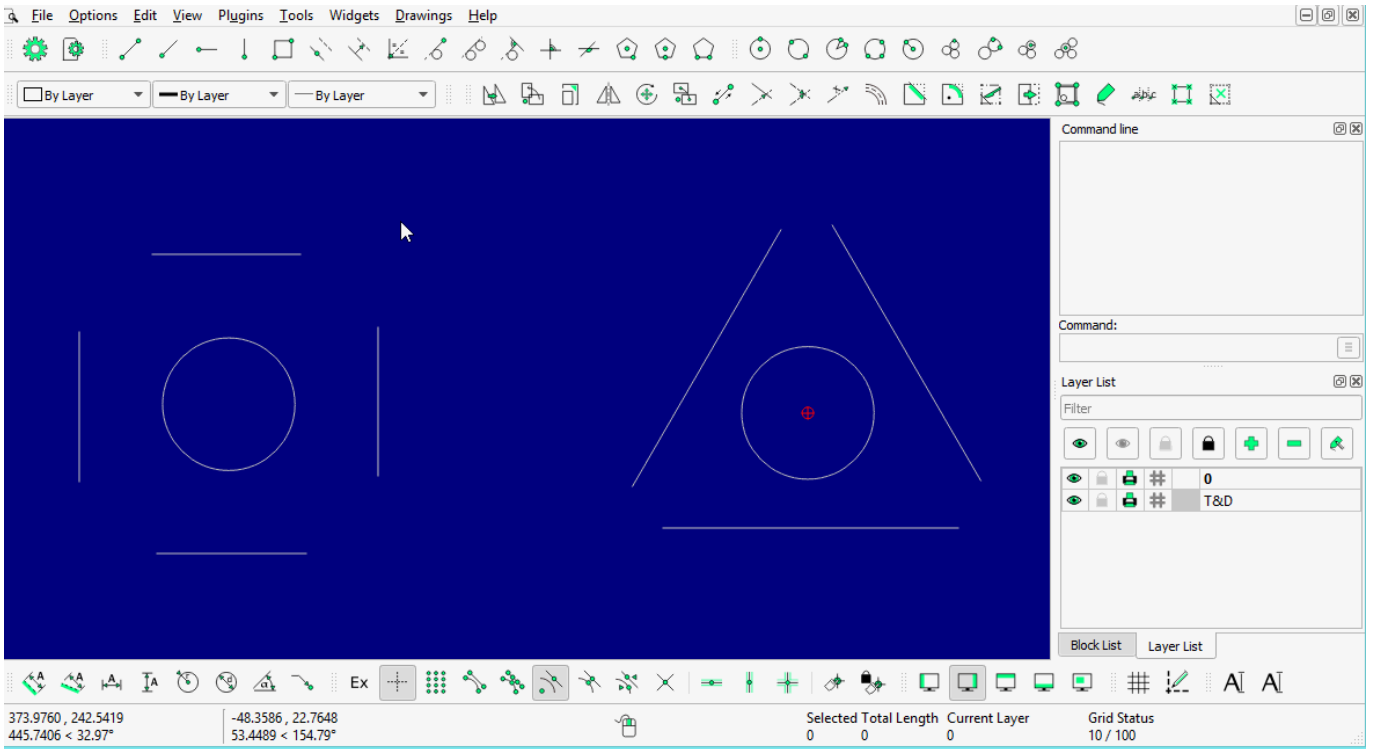

LINE: Orthogonal

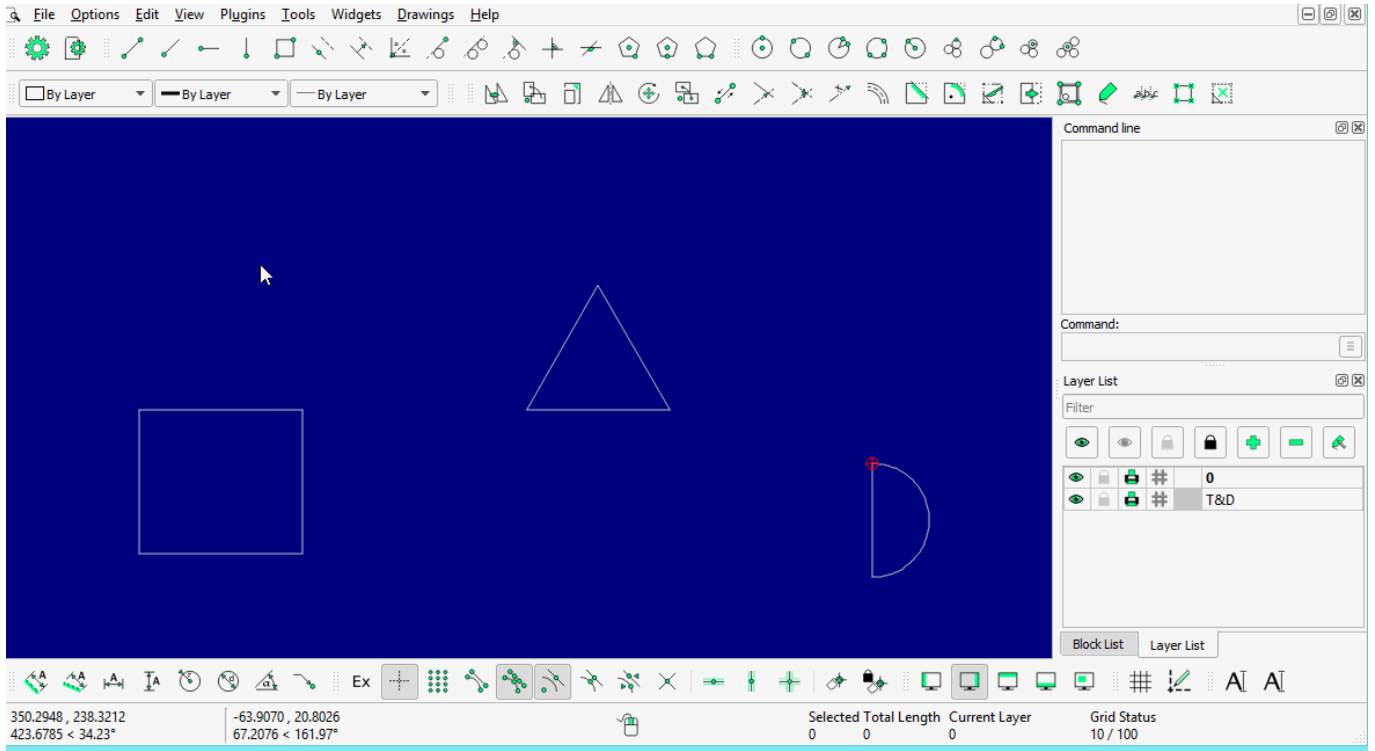

LINE: Relative Angle

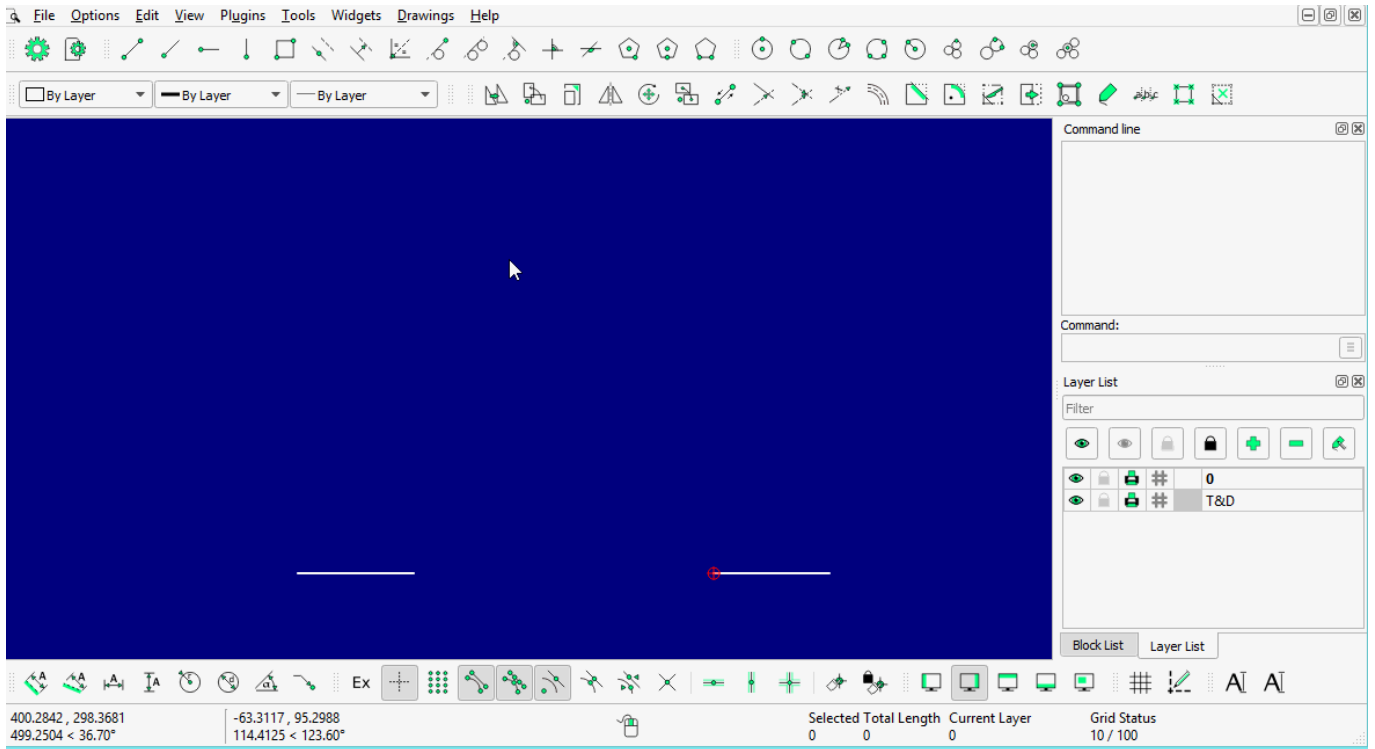

LINE: Polygon [(Cen,Cor), (Cen,Tan), (Cor,Cor)]

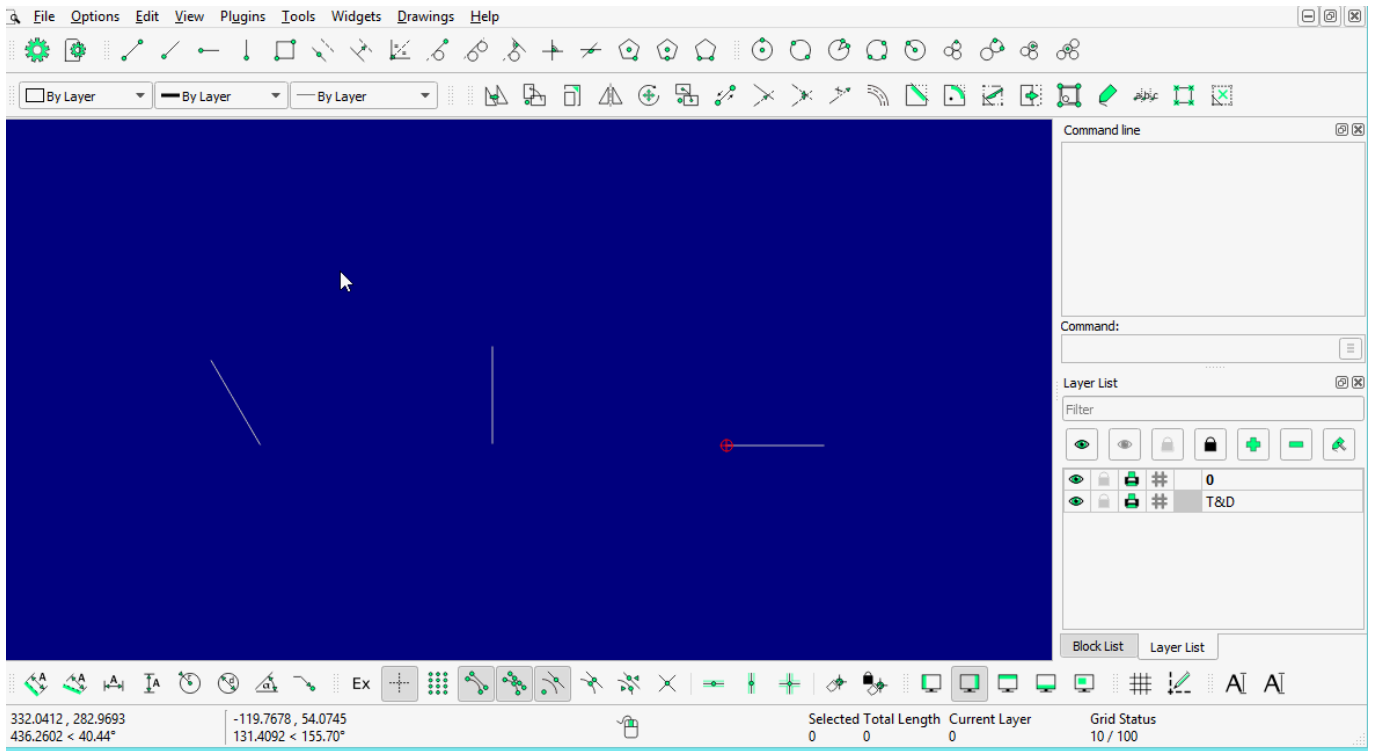

From:

<https://dokuwiki.librecad.org/> - Wiki

Permanent link:

<https://dokuwiki.librecad.org/doku.php/usage:line?rev=1592458697>

Last update: **2020/06/18 05:38**

